

OUTLINK²

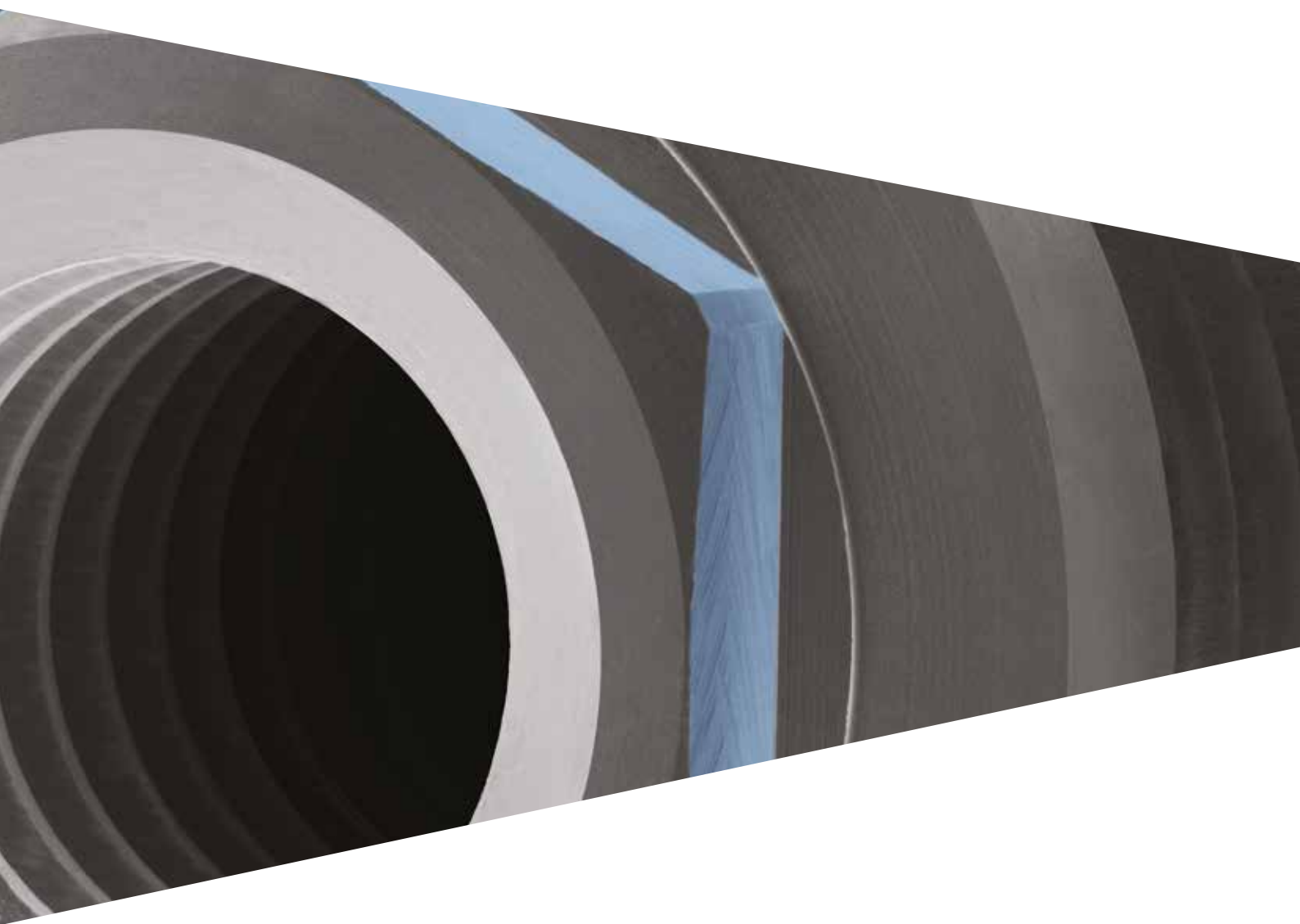

Platform with standard hexagon (2.70 mm)

Outlink² implant system is characterized by a cylindrical endosseous morphology and a connection with an external hexagon. The thread is high performing and self-tapping, and the apex shows three discharge notches allowing the nonrotational aspect of the implant as well as the decompression and the release of the coagulation. **The connection has a 2.70 mm standard hexagon**, with height of 0.70 mm and a threading of M 2.0, and can be found in **Outlink² implants with diameters 3.75 mm, 4.10 mm and 5.00 mm.**

Ø 3.75 mm
(Ø 4.10 mm platform)



Ø 4.10 mm



Ø 5.00 mm



The 5.00 mm diameter makes this implant ideal for implant-prosthetic **rehabilitation on thick bone crest**. Outlink² Ø 5.00 mm implants allow the application of **the Platform Switching protocol** using Ø 4.10 mm prosthetic components.

Outlink² implant with 4.10 mm connection platform **is available in two versions: with 3.75 mm endosseous body and with 4.10 mm endosseous body**. Having the same platform, it is possible to choose between two different connection diameters depending on the thickness of the available bone.

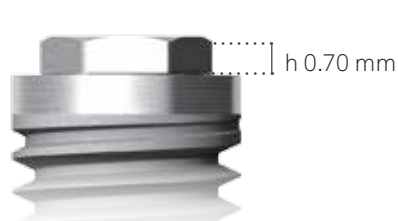

h 0.70 mm



Es. 2.70 mm

Outlink ² lenght range with the 2.70 mm standard hexagon	
Ø 3.75 mm	8.50, 10.00, 11.50, 13.00 mm
Ø 4.10 mm	8.50, 10.00, 11.50, 13.00, 15.00 mm
Ø 5.00 mm	5.00, 7.00, 8.50, 10.00, 11.50, 13.00, 15.00 mm

Platform with 2.40 mm hexagon

The 2.40 mm connection platform characterizes the **Outlink² implants with diameters of 3.00 mm (SLIM), 3.30 mm and 4.10 SP mm** (Platform Switching connection). These implants have the same endosseous geometry and thread of the Outlink² implants with 2.70 mm connection, but in this case the **external hexagon standard is 1.00 mm high to guarantee sturdiness and stability also in case of single crowns rehabilitation at premolar level.**

Ø 3.00 mm



The **Outlink² SLIM** implant has an endosseous diameter of only 3.00 mm, a thread with a pitch of 0.80 mm and 1.80 mm high **transgingival portion**. This implant is indicated for thin crests and generally in case of a reduced mesio-distal space.

Ø 3.30 mm



The thread of **Ø 3.30mm diameter implants** has a pitch of 0.6 mm: this profile **avoids bone trauma after the loading** and support the osseointegration.

Ø 4.10SP mm



The Outlink² Ø 4.10 SP implant has a 4.10 mm prosthetic platform, a 1.00 mm high hexagon with a threading of M1.8, the same as those of Ø 3.30 mm implant. This characteristic **allows the use of the prosthetic components with 3.30 mm diameter**, using the **Platform Switching** protocol.

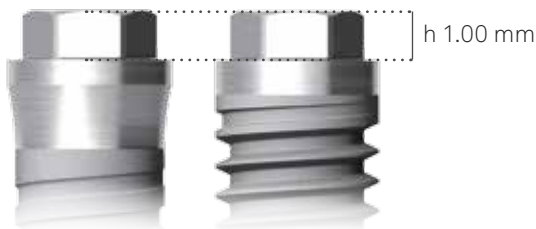

Outlink² length range with the 2.40 mm standard hexagon.

Ø 3.00 mm	10.00, 11.50, 13.00 mm
Ø 3.30 mm	10.00, 11.50, 13.00, 15.00 mm
Ø 4.10SP mm	5.00, 7.00, 8.50, 10.00, 11.50, 13.00, 15.00 mm

Platform Switching

The Platform Switching is a prosthetic rehabilitation protocol that aims to distance the prosthetic connection platform from the cervical bone. The abutment-implant junction is considered as one of the factors responsible for peri-implant bone reabsorption since it can trigger inflammatory reactions.

The geometrical characteristics of Outlink² joints make possible the application according to Platform Switching technique.



The Outlink² Ø 4.10 SP implants has a 4.10 mm prosthetic platform, a 2.40 mm hexagon 1.00 mm high with a threading of M 1.8, the same as those of the Ø 3.30 implants. This characteristic allows the use of the prosthetic components with diameter 3.30 mm, performing the Platform Switching technique **which takes advantages of the horizontal component of the biological width, thus minimising the loss of the crestal bone.**

The Platform Switching technique is possible with Ø 5.00 implants, using Ø 4.10 prosthetic components on these implants. This improves the preservation of the crestal bone.

Clinical case:



4.10SP implants are used adjacent to an aesthetic zone, in order to preserve the bone.



Implants 4 months after the insertion, with the related healing abutments.



Radiological check at 2 years. The Platform Switching allowed the maintenance of the bone pick between the two implants.



Superimposition radiograph /clinical photograph: the benefit is evident both at the bone pick level and from the papillae between implants.

Images and captions by kind permission of Dr. Marco Csonka

Outlink² Shorty

Outlink² Shorty fixtures with height 5.00 mm, 7.00 mm and 8.50 mm are available in the program; they can be used in all cases where there is a reduced vertical bone dimension.

Installing a prosthesis with the Platform Switching technique is recommended for Shorty implants in order to preserve the reduced vertical dimension of the crest as much as possible.

This choice is necessary in Outlink² Shorty implants with 4.10 mm diameter, as they have a 2.40 mm hexagon instead of the 2.70 mm standard hexagon (4.10SP platform).



Multifunctional mounter

The Outlink² implant has the mounter already assembled in the PMMA vial. As well as the traditional carrier function for the transport and positioning of the implant, the particular conformation of the Outlink² mounter, also allows it to be used as a **transfer when taking the impression** and as a **post during prosthetic rehabilitation**. The conical profile of the mounter facilitates insertion and removal of the crowns or of bridges in the case of multiple structures. The golden colour of the mounter/post guarantees maximum results as regards the aesthetic appearance of reconstructions.



The retentive tabs can be cut easily, so that the mounter **adapts to the morphology of the element to be restored** and thus become a practical post.

The mounters with all diameters have two repositioning faces to guarantee a **good non-rotational aspect while taking the impression**. **The thickness of the mounter is such as to allow it to be reduced in height if necessary**, or milled, and to create coulisses in the walls for repositioning the prosthesis.

The mounter is supplied already preassembled with the implant. The connecting screw is also available separately as a spare.

The drivers in the kit have reduced dimensions and allow an easy insertion of the implant also in distal zone or on patient with lacking oral opening.

Furthermore in the kit there are two mounter-stop keys, to allow a fast removal in the pre-operative or intra operative phase for all clinical situations.



Contracone seal

One of the key factors in determining the success of an implant rehabilitation is the absence of bacterial infiltrate. The bacteria, penetrating until the implant-abutment joint level, proliferate and they can start an inflammatory process charged to the tissues around the implant. Sweden & Martina special **micro mechanical production process creates a conical edge on both the implant platform and the abutment** which connects to this implant, granting a peripheral seal able to hinder the bacteria infiltrate at the implant-abutment joint.

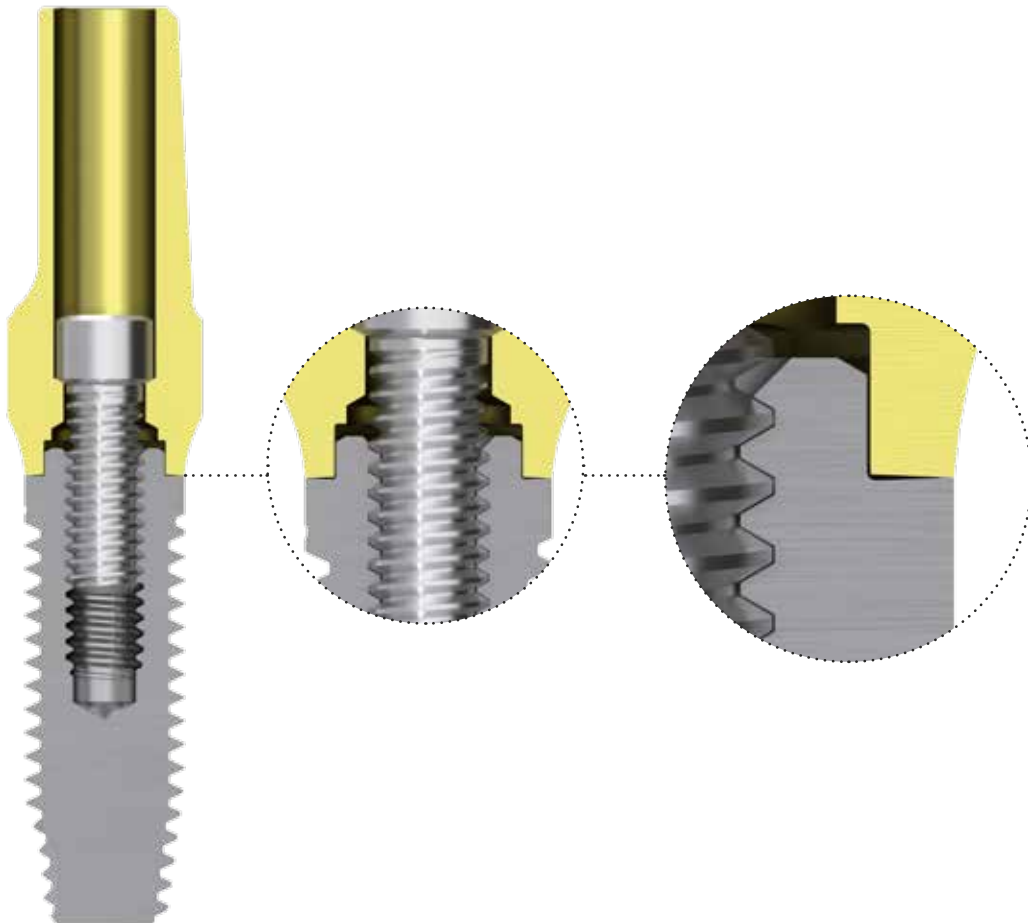

Thanks to the slight conicalness both on the coronal margin of the implant and on the margin of the post, a mechanical barrier is created. In this way a seal is created and it **hinders the bacterial infiltrate, preserving the peri-implant tissues against possible inflammations.**

Microbiological assessment of the implant-abutment interface in different connections: cross-sectional study after 5 years of functional loading

Canullo L., Peñarrocha-Oltra D., Soldini C., Mazzocco F., Peñarrocha M.A., Covani U.
Clin. Oral Impl. Res. 00, 2014, 1–9 doi: 10.1111/clr.12383.

ZirTi Surface

The Outlink² implants are available in the ZirTi surface, **characterized by a machined neck and a body with ZirTi treatment.**

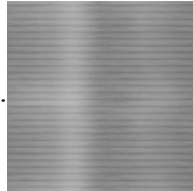
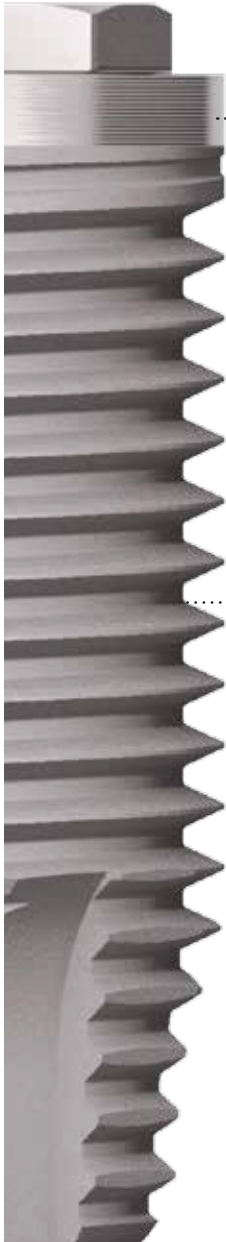

The machined neck allows a perfect control of the connection diameter and **prevents the plaque accumulation on the connection with the post**; moreover, the particular roughness given by the machined neck allows a great adherence of the connection fibers.

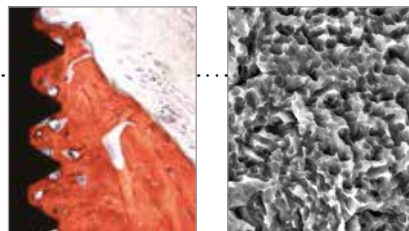

(Histology by kind permission of Dr. Daniele Botticelli)

ZirTi is a surface in which **the roughness is obtained with subtraction** techniques by sand-blasting with zirconium oxide and acid-etching with mineral acids. The **roughness** assumed by the surface of the implant body is an **ideal situation for promoting osteoblastic proliferation and differentiation, as well as the formation and growth of bone tissue.**

Bone healing pattern in surgically created circumferential defects around submerged implants: an experimental study in dog

Rossi F., Botticelli D., Pantani F., Priscila Pereira F., Salata L.A., Lang N.P.
Clin. Oral Impl. Res. 23, 2012; 41–48. doi: 10.1111/j.1600-0501.2011.02170.x

Osteogenesis at implants without primary bone contact – An experimental study in dogs

Sivolella S., Bressan E., Salata L.A., Urrutia Z.A., Lang N.P., Botticelli D.
Clin. Oral Impl. Res. 23, 2012, 542–549 doi: 10.1111/j.1600-0501.2012.02423.x

Bone-healing pattern at the surface of titanium implants: an experimental study in the dog

Rossi F., Lang N.P., De Santis E., Morelli F., Favero G., Botticelli D.
Clin. Oral Impl. Res. 00, 2013, 1–8 doi: 10.1111/clr.12097

Hard and soft tissue changes around implants installed in regular-sized and reduced alveolar bony ridges. An experimental study in dogs

Baffone G., Lang N.P., Pantani F., Favero G., Ferri M., Botticelli D.
Clin. Oral Impl. Res. 00, 2013, 1–6 doi: 10.1111/clr.12306

Complete surgical kit

The Outlink² surgical kit is designed to offer ease of use and ergonomics, **it contains all the instruments needed for the surgical and prosthetic phase**. The instruments categories are screen-printed on the tray to allow dental assistants to identify each instrument more easily and to reposition after cleasing and cleaning phase.

Furthermore, small kits are available dedicated to the surgical phase, to the prosthetic phase, and to the insertion of Shorty implants.

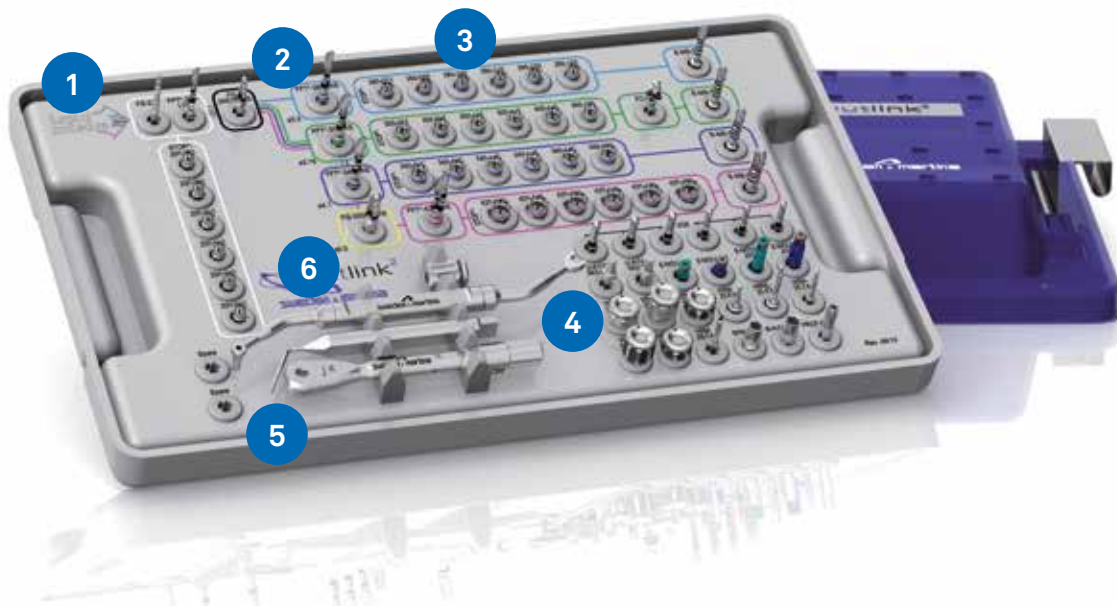

1 Intuitive path printed on the tray

- Instruments use sequence indicated by **colored marks following the color code** of Outlink² implants.
- **Rapid and intuitive management** of each instrument.

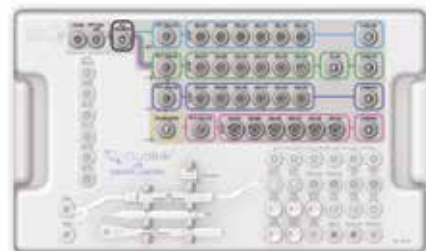

2 Precision drill, countersink and initial drills with depth stops

- Precision drill **to slice the cortical**, therefore sharp and cutting.
- Countersink drill to **prepare the coronal part** of the site in case of implants with a prosthetic platform wider than the diameter of the spires.
- Initial drills provided with **laser notches to indicate the depth** of work and supplied with the relative **depth stops**.



3

Final drills and related depth stops

- Final drills with a **number of cutting edges proportional** to the hole diameter, to enable high-precision implant preparations.
- The depth stops guarantee a **preparation in complete safety**.



4

Driver for mounter

- **Small driver** that allows an easy insertion also in distal sector or on patients with limited oral opening.
- Available with right-angle attachment or for torque-control ratchet



5

Torque-control ratchet

- Ratchet that performs both the **dynamometric function and of fixed key**.
- Possibility of **controlling the torque** from 10 to 70 Ncm, therefore ensuring absolute precision from the implant site preparation phase to the screwing of the prosthetic components.



6

Mounter stop keys

- **2 mounter-stop keys** available inside the kit, to allow a rapid pre-operative or intra-operative removal of the mounter in any clinical situation.



Wide range of prosthetic solutions

The prosthetic solutions are extremely versatile for all the Sweden & Martina implant systems. Please refer to each catalogue for further details.

Impression and model phase

- Pick-up transfer
- Pull-up transfer
- Closed tray transfer
- Analogues



SIMPLE temporary posts

- Straight emergence
- Anatomical emergence



Pre-made posts

- Straight
- Angled at 15°
- Angled at 25°



Millable posts

- Straight
- Pre-angled
- Anatomical emergence



Fully castable posts, or castable posts with base in alloy, titanium or cobalt chrome

- Repositionable
- Non-repositionable
- Straight emergence
- Anatomical emergence



P.A.D. Disparallel Screwed Prosthesis

- Direct screw-retained abutments straight and angled at a 17° and 30°



Individualised prosthesis ECHO2

- Individual posts in: titanium, zirconium, cobalt chrome
- Screw-retained bar structures in milled cobalt chrome and milled biotitanium
- Screw-retained bridge structures and Direct Bridges in zirconium, milled cobalt chrome, milled biotitanium PMMA and fiberglass



Prosthesis on intermediate abutments

- Transfers
- Analogues
- Abutments
- Sleeves



B.O.P.T. prosthesis

- B.O.P.T. healing abutment in titanium
- B.O.P.T. temporary posts made of REEF resin
- B.O.P.T. millable posts in titanium



Locator abutments for overdentures

- Abutments and caps for attaching overdentures to the implants





rev. 09-15



Sweden & Martina S.p.A.

Via Veneto, 10
35020 Due Carrare (PD), Italy
Tel. +39.049.9124300
Fax +39.049.9124290
info@sweden-martina.com
www.sweden-martina.com

Sweden & Martina Mediterranea S.L.

Sorolla Center, Oficina 801
Avda Cortes Valencianas 58, 8pl
46015-Valencia, España
Tel. +34.96.3525895
Tel. 900993963
info.es@sweden-martina.com

Sweden & Martina Inc.

One Embarcadero Center
Suite#504
San Francisco, CA94111
USA
Toll free (844)8MARTINA/844.862.7846
info.us@sweden-martina.com

The implants, prosthetic components and surgical instruments illustrated in this brochure are medical devices manufactured by Sweden & Martina SpA, except for Locator abutments, which are medical devices manufactured and patented by Zest Anchors, Inc., 2061 Wineridge Place, Escondido, CA 92029, USA. The European Authorized Representative of Zest Anchors for the purposes of the Medical Devices Directive 93/42/EEC is Ventura Implant and Attachment Systems, 69 The Avenue, Ealing, London W13 8JR, England.
The articles illustrated in this brochure are compliant with the UNI EN ISO 9001:2008/UNI EN 13485:2012 standards, and are registered as CE Mark (Class I) and CE Mark 0476 (Class IIA and Class IIB) in accordance with the European Medical Devices Directive 93/42/EEC and European Directive 2007/47/EC.

Sweden & Martina production facilities manufacture medical devices in accordance with the cGMPs applicable in the USA and other countries.



Some products may not be available on all markets.

All brand names present in this brochure are the property of Sweden & Martina, except for those products for which other indications are given. These products are intended for dental clinics and dental technology laboratories, and are not intended for direct sale to patients.

It is prohibited to sell, duplicate or disclose the products illustrated in this brochure without the prior written consent of Sweden & Martina S.p.A. For further information on the products illustrated, including indications, contraindications, warnings, precautions and potential side-effects, please consult the Sweden & Martina S.p.A website.

Contents are correct at the time of publication. Please contact Sweden & Martina SpA for information on any subsequent updates.